

# Cyaneus GPS Co-planar Antenna

Part No. A10137

Product Specification

## 1 Features

- GPS antenna designed for embedded applications
- Balanced antenna technology
- High efficiency
- Good resistance to de-tuning
- Intended for SMD mounting
- Supplied in tape on reel
- Low height, small footprint, light weight

## 2 Description

Cyaneus GPS Co-planar antenna is intended for reception of GPS signals at 1575 MHz.

The antenna uses a ground plane in order to radiate efficiently, which should be at least 20 x 30 mm. It should be noted that the radiation patterns change with the size of the ground plane.

The antenna has RHCP characteristics suitable for reception of GPS signals. The antenna patterns are given in section 7-3 “Antenna Patterns”

## 3 Applications

- Antenna for mobile phones and handheld devices with embedded GPS systems
- Application specific tracking modules
- Mapping software accessories: USB dongle, SDIO cards, PCMCIA card



## 4 Part number

Cyaneus: A10137



## 5 General data

|                         |                     |
|-------------------------|---------------------|
| Product name            | Cyaneus             |
| Part Number             | A10137              |
| Frequency               | GPS - 1575 MHz      |
| Polarization            | Linear              |
| Operating temperature   | -40 °C to +85 °C    |
| Impedance with matching | 50 Ω                |
| Weight                  | 0.7 g               |
| Antenna type            | SMD                 |
| Dimensions              | 9 x 20.1 x 1.6 [mm] |

## 6 Electrical characteristics

|                             | Typical performance<br>Reference Board<br>A10137-R | Typical performance<br>Reference Board<br>A10137-D | Conditions   |
|-----------------------------|--|--|--|
| Bandwidth                   | >20 MHz at -10 dB<br>Return Loss                   | >30 MHz at -10 dB<br>Return Loss                   | All data measured on<br>Antenna's reference<br>boards, part numbers<br>A10137-R and A10137-D<br><br>Data given for the<br>1573.42 – 1577.42 MHz<br>frequency range |
| Peak gain (Linear)          | 0.9 dBi  | 0.9 dBi  |  |
| Average gain (Linear)       | -2.2 dBi   | -1.6 dBi   |  |
| Average efficiency (Linear) | 61%  | 69%  |  |
| Peak gain (RHCP)            | 0.1 dBic   | -1.7 dBic  |  |
| Average gain (RHCP)         | -5.1 dBic  | -4.6 dBic  |  |
| Average efficiency (RHCP)   | 31%  | 34.5%  |  |
| Maximum Return Loss         | -15 dB   | -15 dB   |  |
| Maximum VSWR                | 1.4:1  | 1.4:1  |  |

## 7 Electrical performance

### 7-1 Return Loss

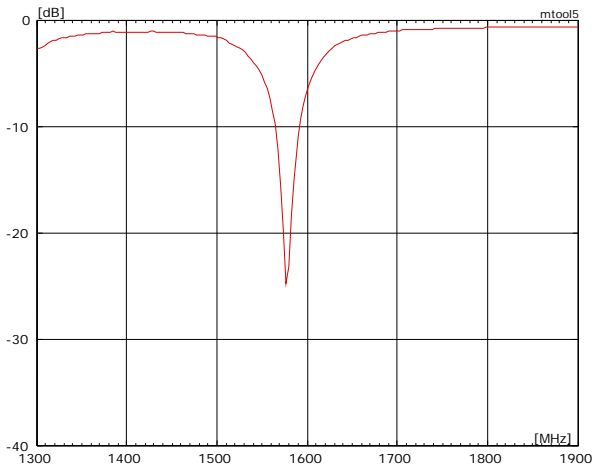

Reference Board A10137-R-U1

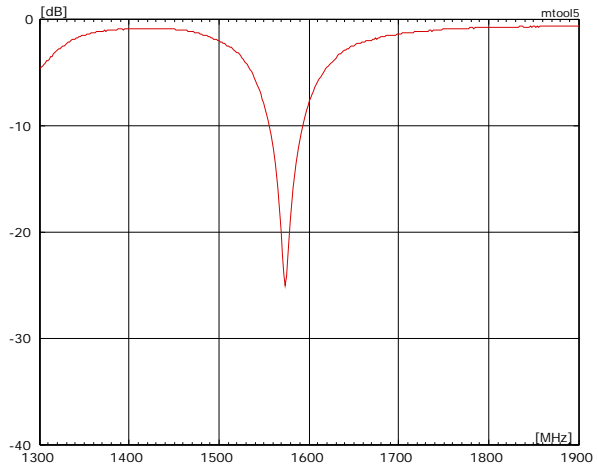

Reference Board A10137-D

### 7-2 VSWR

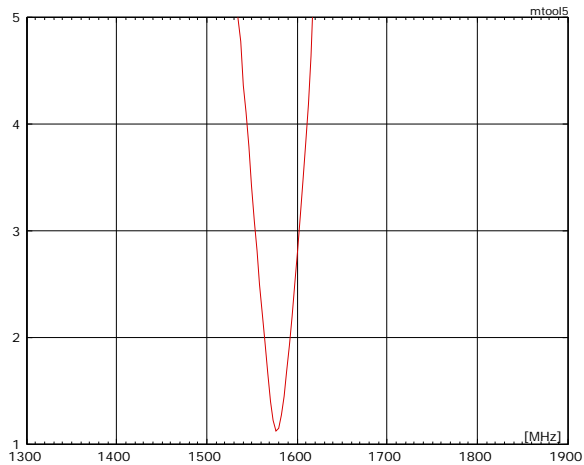

Reference Board A10137-R-U1

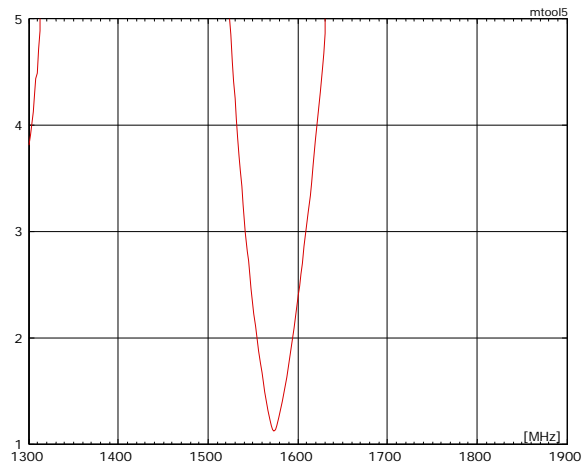

Reference Board A10137-D

### 7-3 Antenna patterns

#### 7.3.1. Reference Board A10137-R-U1 [Linear Polarization]

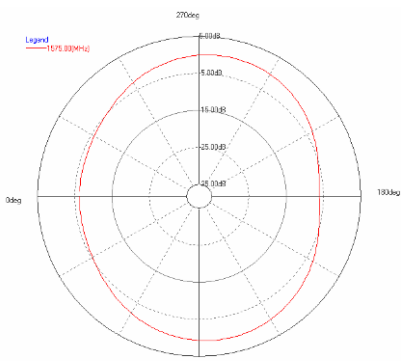
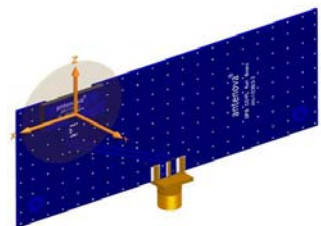
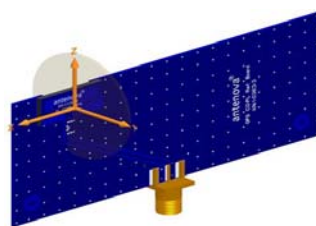
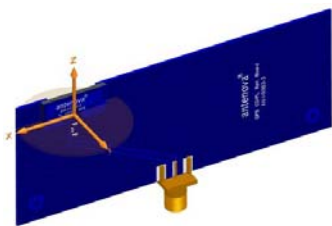
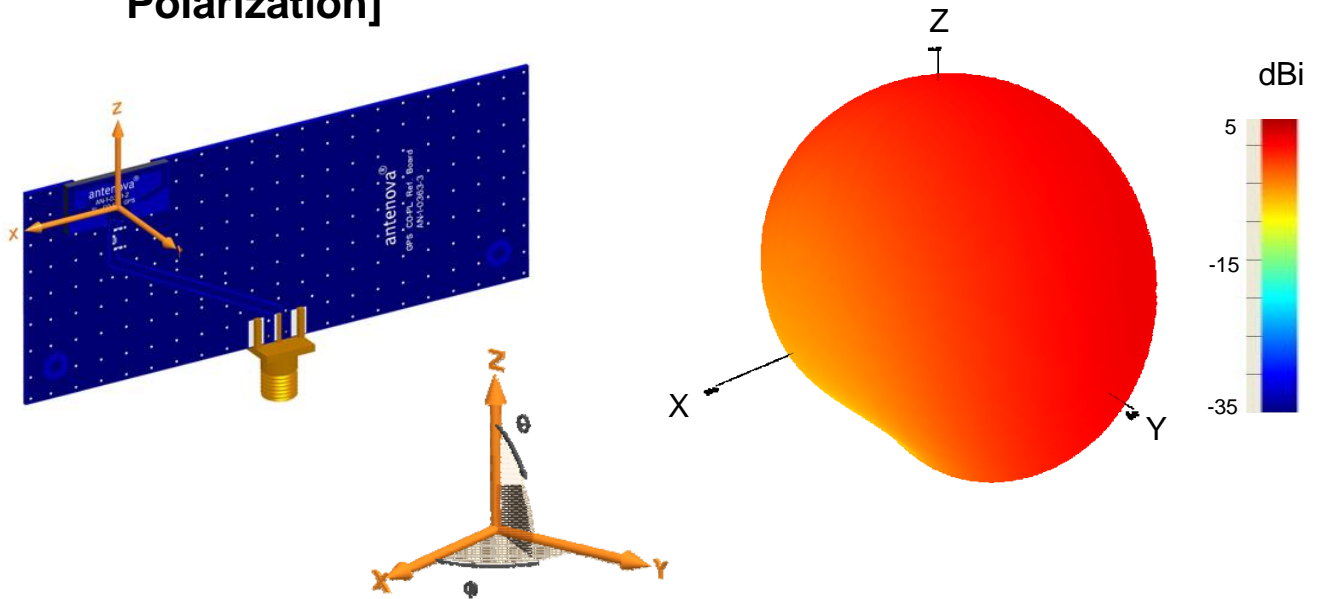

XY plane

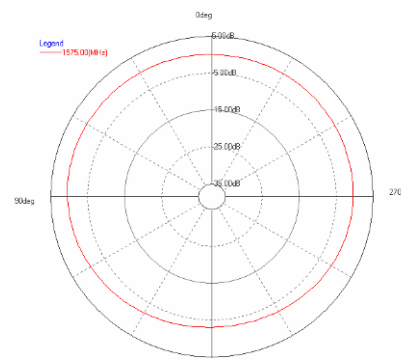

ZY plane

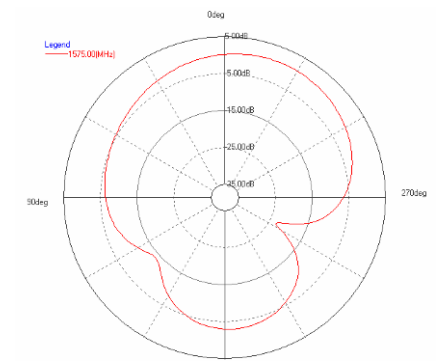

XZ plane

Patterns show combined polarisations  
measured on reference board A10137-R-U1

### 7.3.2. Reference Board A10137-R-U1 [RHCP]

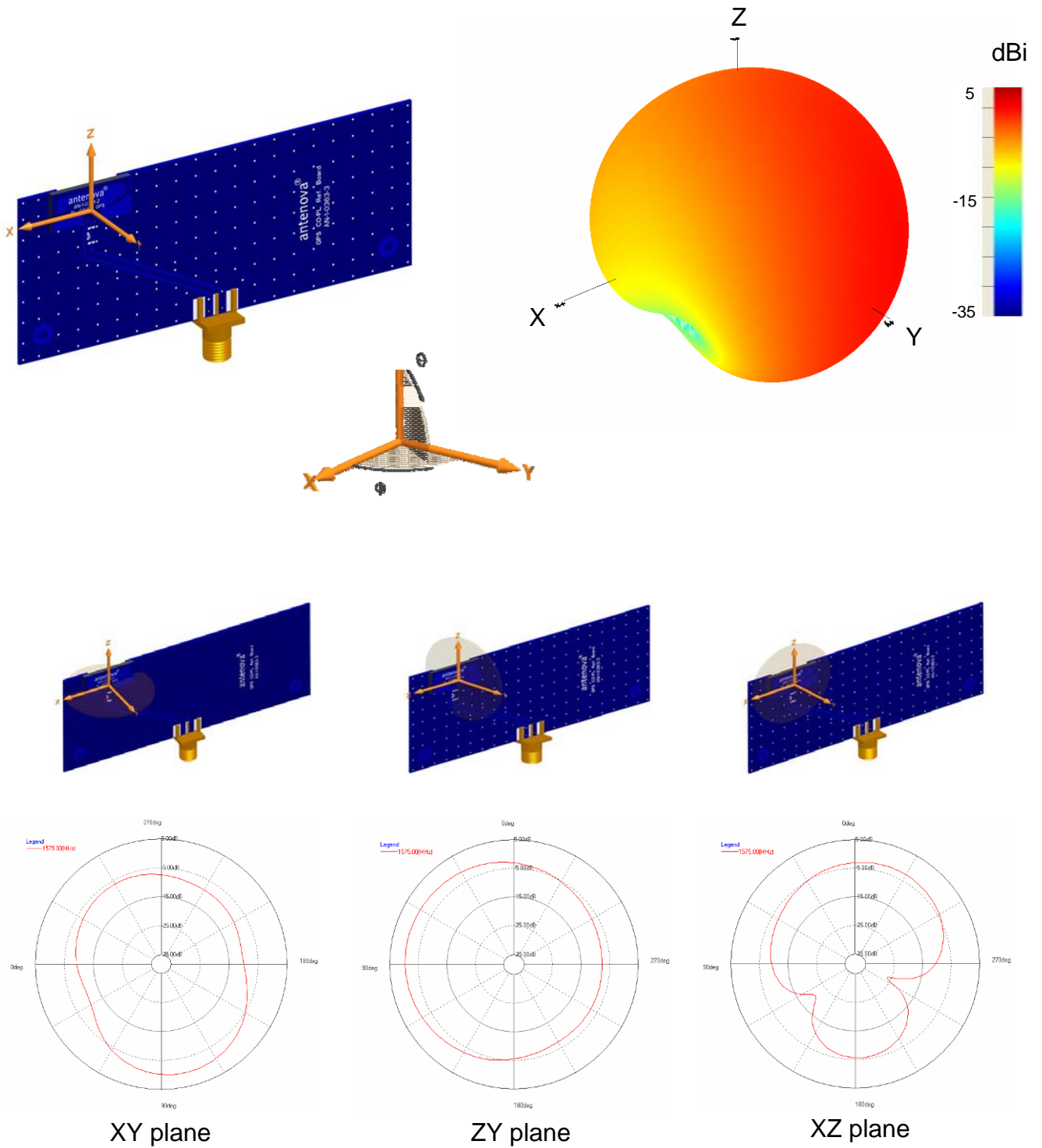

### 7.3.3. Reference Board A10137-D [Linear Polarization]

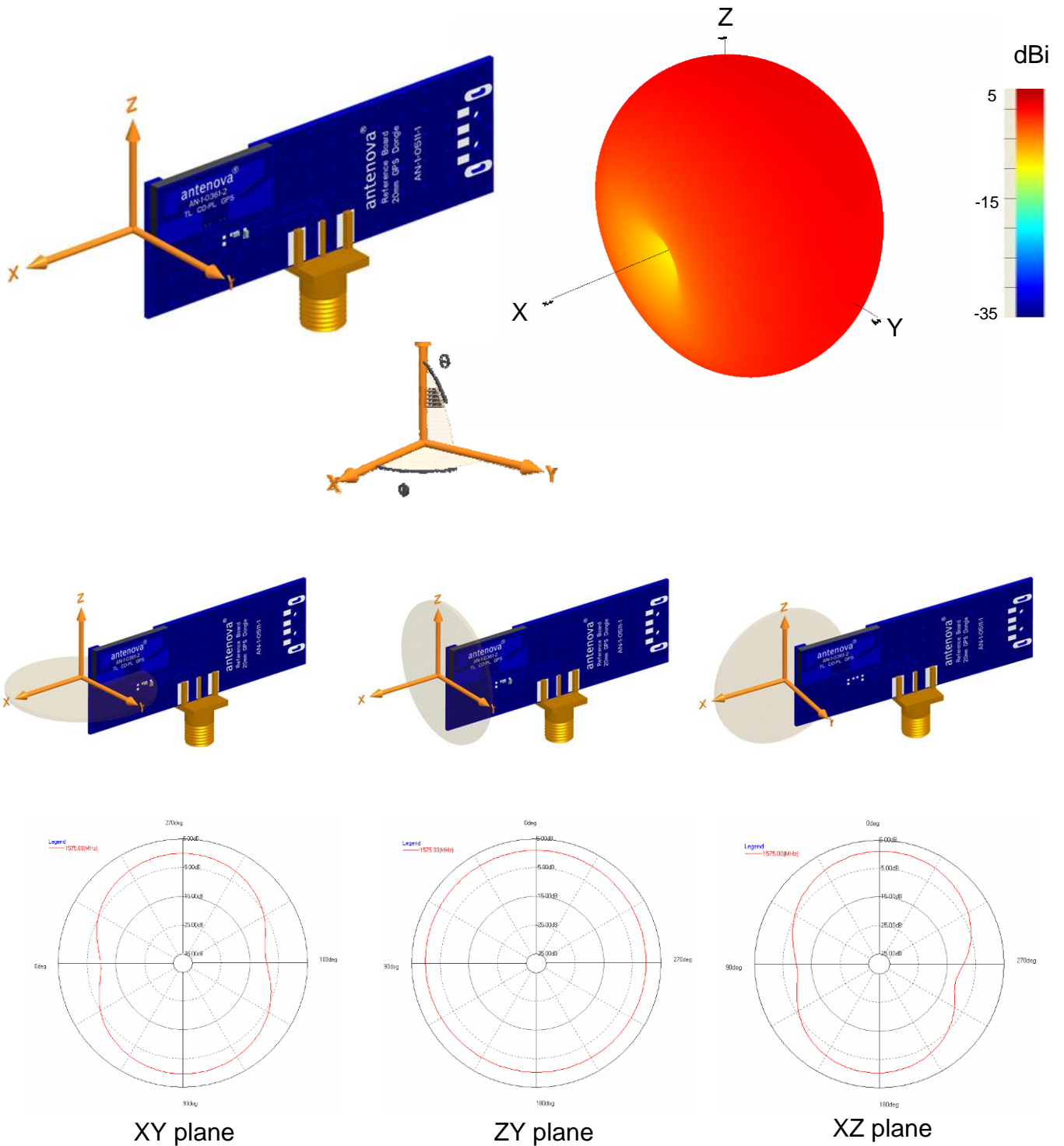

Patterns show combined polarisations measured on reference board A10137-D

### 7.3.4. Reference Board A10137-D [RHCP]

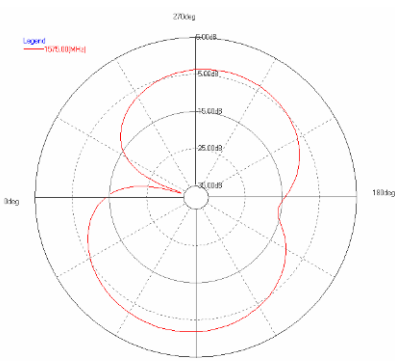
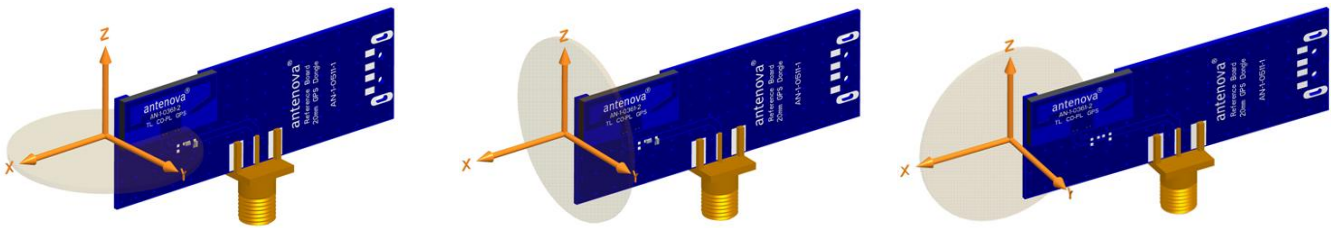
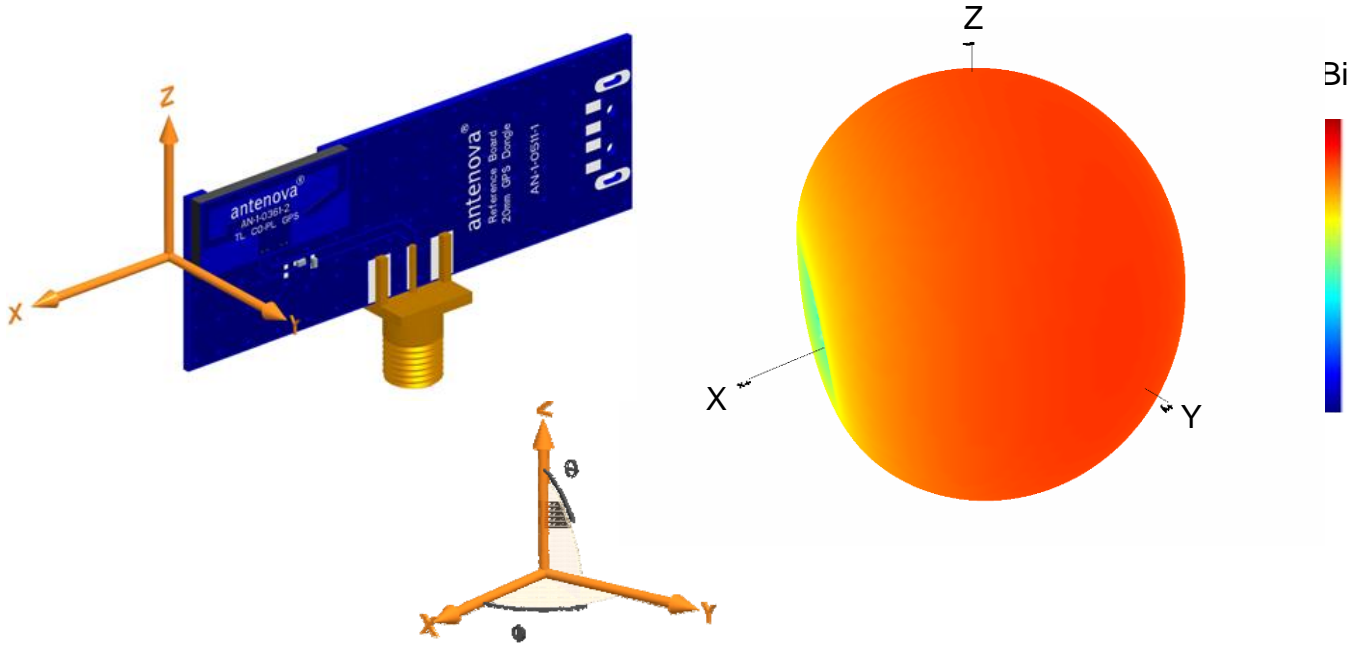

XY plane

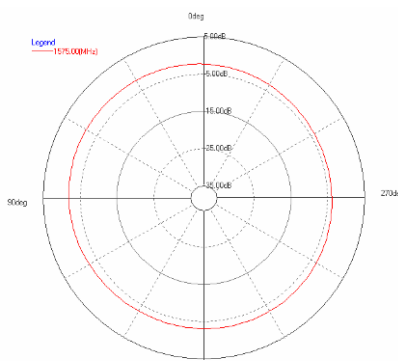

ZY plane

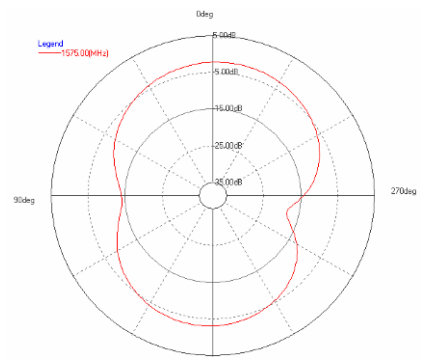

XZ plane

## 8 Antenna dimensions

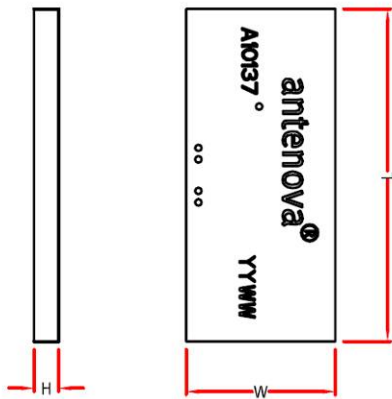

| L              | W             | H              |
|----------------|---------------|----------------|
| Length         | Width         | Height         |
| $20.1 \pm 0.2$ | $9.0 \pm 0.2$ | $1.5 \pm 0.15$ |

Dimensions in mm

## 9 Antenna footprint

GPS Co-planar (Part No: A10137)

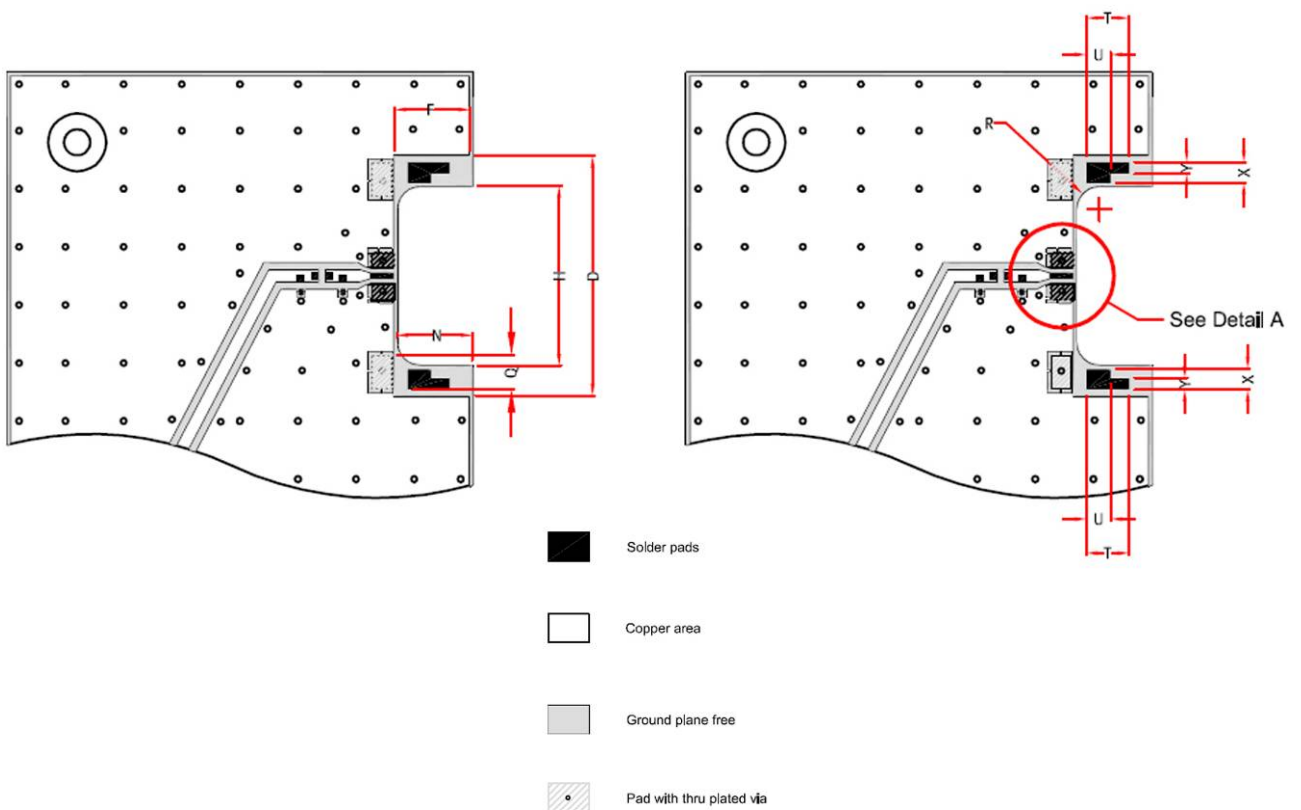

\* CAD files of the antenna footprint are available from Antenova on request.  
Please contact [info@antenova.com](mailto:info@antenova.com) for further details.

Integrated Antenna and RF Solutions

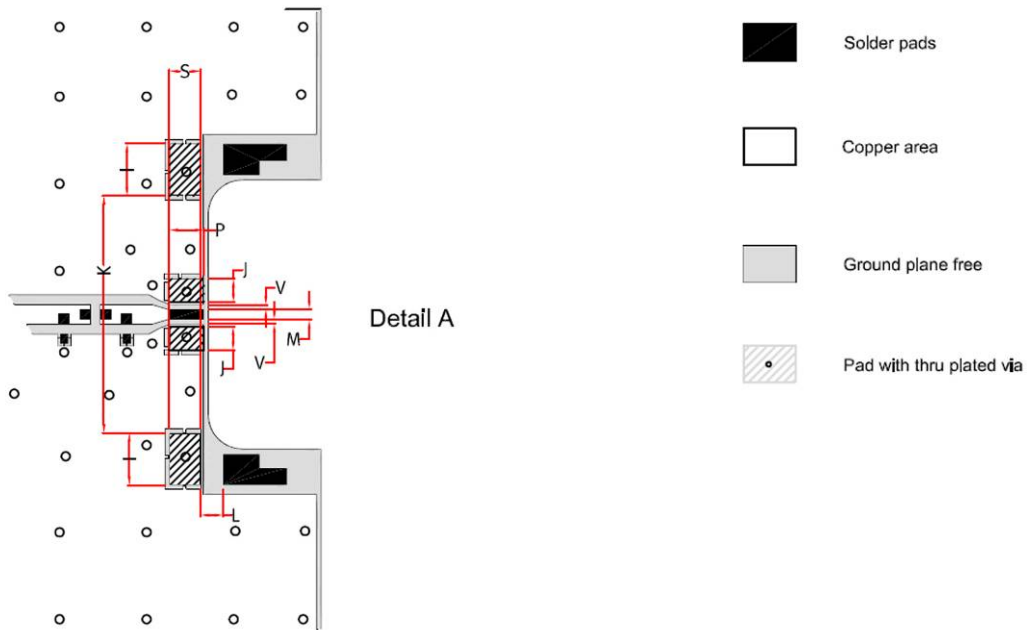

\* CAD files of the antenna footprint are available from Antenova on request.  
Please contact [info@antenova.com](mailto:info@antenova.com) for further details.

| D           | F   | I   | J    | H    | K    | L   | M   | N   | P   | Q   | R   | S   | T    | U   | V    | X   | Y   |
|-------------|-----|-----|------|------|------|-----|-----|-----|-----|-----|-----|-----|------|-----|------|-----|-----|
| min<br>20.6 | 6.5 | 3.0 | 1.35 | 15.5 | 13.6 | 1.3 | 0.6 | 6.5 | 2.0 | 3.0 | 2.0 | 1.8 | 3.68 | 2.1 | 0.25 | 1.8 | 1.0 |

Dimensions in mm. Tolerances for all dimensions on this table are  $\pm 0.1$  mm.  
Dimension D stated is a minimum. Depending on the application, it can be extended to optimise the antenna performance. For more details, please contact [info@antenova.com](mailto:info@antenova.com)

## 10 Electrical interface

### 10-1 Transmission lines

- All transmission lines should be designed to have a characteristic impedance of  $50 \Omega$
- The length of the transmission lines should be kept to a minimum
- Any other parts of the RF system like transceivers, power amplifiers, etc, should also be designed to have an impedance of  $50 \Omega$

Once the material for the PCB has been chosen (PCB thickness and dielectric constant), a coplanar transmission line can easily be designed using any of the commercial software packages for transmission line design. For the chosen PCB thickness, copper thickness and substrate dielectric constant, the program will calculate the appropriate transmission line width and gaps on either side of the track so the characteristic impedance of the coplanar transmission line is  $50 \Omega$ .

### 10-2 Matching circuit

The antenna requires a matching circuit that must be optimized for each customer's product. The matching circuit will require up to three components and the following pad layout should be designed into the device so the correct circuit can be installed:

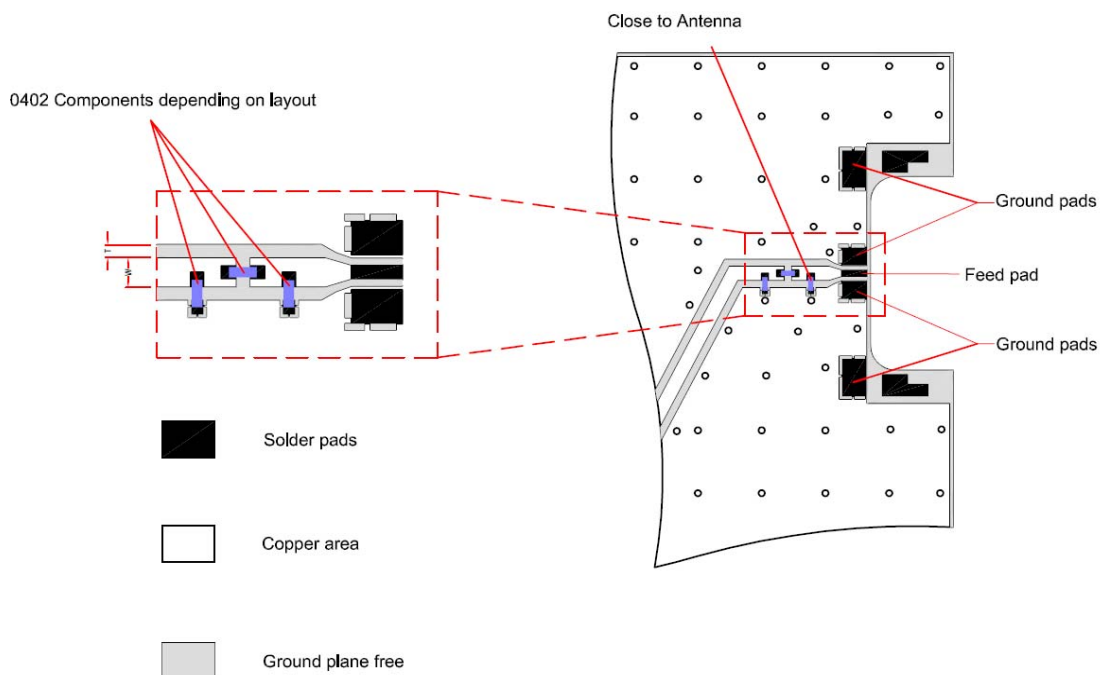

The antenna feed pad and the antenna ground pads are indicated in the drawing above. Additional pads are for mechanical attachment only and should not be grounded.

In addition to the matching circuit, a separate DC blocking capacitor will also be required between the radio and the antenna matching circuit.

**Note: The component values for the matching circuit will vary depending on the size of the PCB and surrounding components.** The impedance of the antenna should be measured before selecting suitable matching components. Antenova offers this service on request. Contact [info@antenova.com](mailto:info@antenova.com) for further information.

### 10-3 Antenna placement

Antenova strongly recommends placing the antenna at the edge of the board with a cut out area as shown in the antenna footprint (Section 9). Maximum antenna performance is achieved by placing the antenna towards one of the corners of the PCB.

### 10-4 Reference boards

The reference boards have been designed for evaluation purposes of the Cyaneus Co-planar antenna and they include a SMA female connector.

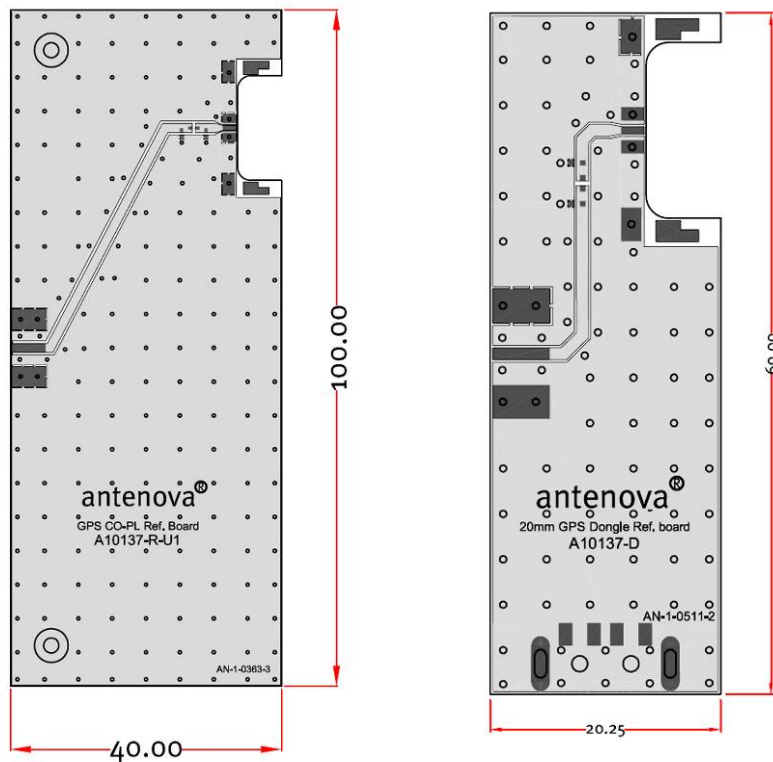

A10137-R-U1

A10137-D

Dimensions in mm

Contact [info@antenova.com](mailto:info@antenova.com) for further details

## 11 Soldering

This antenna is suitable for lead free soldering.

The reflow profile should be adjusted to suit the device, oven and solder paste, while observing the following conditions:

- The maximum temperature should not exceed 240 °C
- However for lead free soldering, a maximum temperature of 255 °C for no more than 20 seconds is permitted.
- The antenna should not be exposed to temperatures exceeding 120 °C more than 3 times during the soldering process.

## 12 Hazardous material regulation conformance

The antenna has been tested to conform to RoHS requirements. A certificate of conformance is available from Antenova's website.

## 13 Packaging

### 13-1 Optimal storage conditions for packaged reels

|                      |   |
|----------------------|---|
| <b>Temperature</b>   | -10°C to 40°C   |
| <b>Humidity</b>      | Less than 75% RH  |
| <b>Shelf Life</b>    | 18 Months   |
| <b>Storage place</b> | Away from corrosive gas and direct sunlight                                 |
| <b>Packaging</b>     | Reels should be stored in unopened sealed manufacturer's plastic packaging. |

**Note: Storage of open reels of antennas is not recommended due to possible oxidization of pads on antennas. If short term storage is necessary, then it is highly recommended that the bag containing the antenna reel is re-sealed and stored in like storage conditions as in above table.**

### 13-2 Tape characteristics

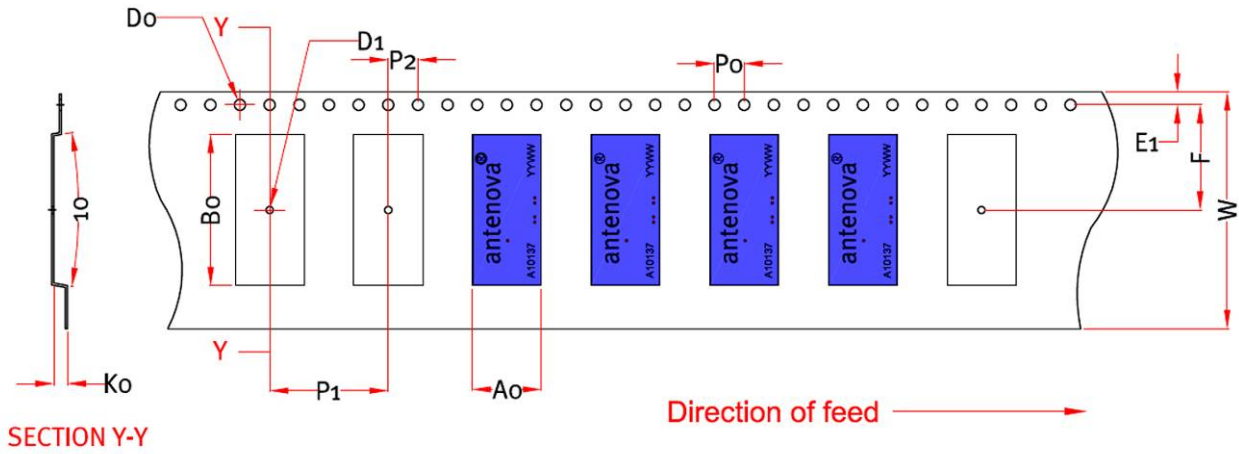

| W        | F          | E1         | P0      | P1       | P2      | A0        | B0         | K0        | T          | D0      | D1      |
|----------|------------|------------|---------|----------|---------|-----------|------------|-----------|------------|---------|---------|
| 32 ± 0.2 | 14.2 ± 0.1 | 1.75 ± 0.1 | 4 ± 0.1 | 16 ± 0.1 | 2 ± 0.1 | 9.3 ± 0.1 | 20.4 ± 0.1 | 1.8 ± 0.1 | 0.3 ± 0.05 | Min 1.5 | Min 1.5 |

Dimensions in mm

| Quantity        | Leading Space            | Trailing Space           |
|-----------------|--------------------------|--------------------------|
| 1000 pcs / reel | 50 blank antenna holders | 50 blank antenna holders |

### 13-3 Reel dimensions

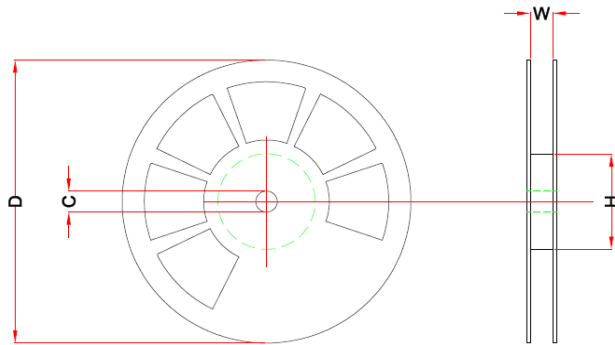

| Width (W) | Reel Diameter (D) | Hub Diameter (H) | Shaft Diameter (C) |
|-----------|-------------------|------------------|--------------------|
| 33.5 mm   | 330 mm (13")      | 80 mm            | 13 mm              |

### 13-4 Box dimensions

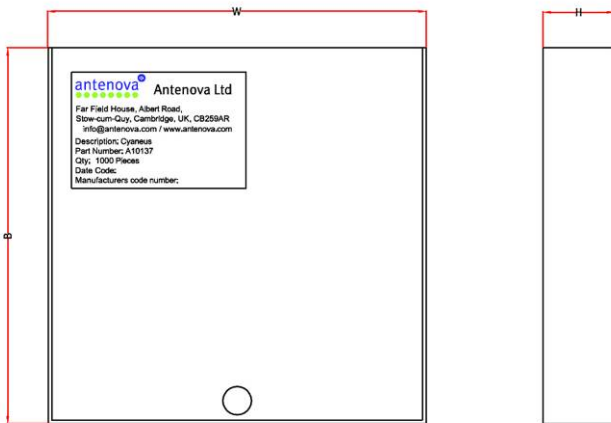

| Width (W) | Breadth (B) | Thickness (H) |
|-----------|-------------|---------------|
| 345 mm    | 345 mm      | 45 mm         |

### 13-5 Bag properties

Reels are supplied in protective plastic packaging

### 13-6 Reel label information

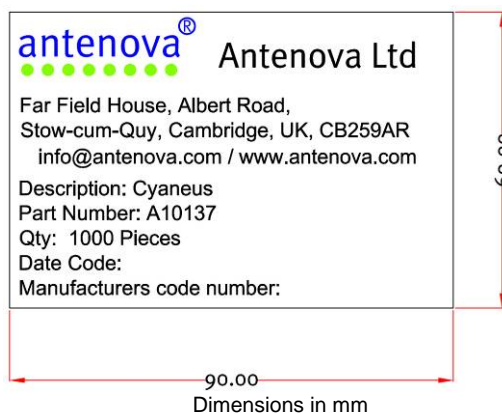



**[www.antenova.com](http://www.antenova.com)**

**Corporate Headquarters**

Antenova Ltd.  
Far Field House  
Albert Road  
Stow-cum-Quy  
Cambridge  
CB25 9AR

**Tel:** +44 1223 810600  
**Fax:** +44 1223 810650  
**Email:** [info@antenova.com](mailto:info@antenova.com)

**North America Headquarters**

Antenova Ltd.  
Rogers Business Park  
2541 Technology Drive Suite 403  
Elgin, IL 60124

**Tel:** +1 (847) 551 9710  
**Fax:** +1 (847) 551 9719  
**Email:** [info@antenova.com](mailto:info@antenova.com)

**Asia Headquarters**

Antenova Asia Ltd.  
4F, No. 324, Sec. 1, Nei-Hu Road  
Nei-Hu District  
Taipei 11493  
Taiwan, ROC

**Tel:** +886 (0) 2 8797 8630  
**Fax:** +886 (0) 2 8797 6890  
**Email:** [info@antenova.com](mailto:info@antenova.com)

**Copyright® 2009 Antenova Ltd.** All Rights Reserved. Antenova® and gigaNOVA® are trademarks of Antenova Ltd. Any other names and/or trademarks belong to their respective companies.

The materials provided herein are believed to be reliable and correct at the time of print. Antenova does not warrant the accuracy or completeness of the information, text, graphics or other items contained within these information. Antenova further assumes no responsibility for the use of this information, and all such information shall be entirely at the user's risk.



Certificate No: 4598

**Integrated Antenna and RF Solutions**